



MODEL AND SIMULATION OF SMART DOORLOCK SYSTEM USING RADIO FREQUENCY IDENTIFICATION BASED ON MICROCONTROLLER

Andri Sukmaindrayana^{1*}, Agus Ramdhani Nugraha², Dadang Haryanto³,
Aneu Yuliane⁴

^{1,2}Informatics Engineering, STMIK DCI, Tasikmalaya, Indonesia

^{3,4}Informatics Management, STMIK DCI, Tasikmalaya, Indonesia

E-mail ^{1*}sukmaindrayana@gmail.com

Abstract

This study aims at the application of Radio Frequency Identification (RFID) used on the door. The RFID used is based on Arduino Uno and is integrated with the Mifare RC-522 RFID reader. The aim is to create a safety device and automatic door opener that can practically increase the feeling of security and comfort in opening the door of the house, without having to use various keys which may be very inconvenient. The method used is the waterfall, with research stages carried out problem identification, system analysis, system design, tool assembly program coding, and system testing. The results show that when the RFID tag is brought closer to the RFID reader, the door opens. Then, when the RFID tag used is not appropriate, the buzzer will sound. The reading distance of each RFID tag by the RFID reader is 4 cm. In addition, objects or barrier media between the RFID tag and the RFID reader also determine the success of data reading. The key used is a selenoid doorlock with the help of a relay.

Keywords: Smart Doorlock, Radio Frequency Identification, Microcontroller, Arduino Uno.

DOI Number: 10.48047/NQ.2022.20.16.NQ880358

NeuroQuantology2022;20(16):3524-3535

INTRODUCTION

According to the Indonesian Central Bureau of Statistics (2021), revealed the crime of theft is the most common crime in Indonesia, with 37,778 incidents of theft occurring in 2018 (Statistik, 2021). Lack of security is one of the reasons for the occurrence of theft crimes, some of the deficiencies that are often found in security systems include the difficulty of opening locks when used, easy to break, easily damaged keys, and easily duplicated keys (Rathke, 2021).

The rapid development of science and technology has triggered the emergence of many new technologies, one of which is Radio Frequency Identification (RFID). RFID is a process of identifying objects or objects using radio transmission frequencies (Sudarto et al., 2017). RFID is also a new technology that will continue to develop according to technological advances that continue to increase, so it is certain that RFID can be applied in various fields, including identifying those engaged in logistics, warehousing, manufacturing, security services, and others (Chen et al., 2020). Research conducted by



Bibi et al. (2017), RFID has two important components that are used, namely tags that function to store data remotely and readers to read data from each tag by emitting radio waves with a certain frequency. The existence of RFID can facilitate work related to data input or identifying goods (Bibi et al., 2017).

RFID is a development of the previous identification system, namely the Barcode. The fundamental difference between RFID and barcodes lies in the way a transponder is read or the device used as a label (Baloch et al., 2018). For barcodes, usually, the reading is done directly and the position between the tag and the reader must be correct. Otherwise, the tag cannot be read by the reader. In contrast to RFID, only by bringing the tag closer to the reader, the tag can be identified. In addition, time is saved due to the speed in reading the information contained in RFID tags much faster compared to barcodes and other technologies. This RFID technology can also be relied upon by connecting other technologies.

For example, RFID is connected to sensors for library exits and circulation systems to identify items leaving the library (Shahid, 2005). If someone ran out of the library and couldn't be intercepted, the library at least knew what had been stolen. If the membership card also has an RFID tag, the library will also be able to determine who can issue items (library materials). Minimized theft and cost savings. In addition, RFID tags last longer than barcodes because there is no direct contact with the item. Most RFID vendors claim there is a minimum of 100,000 transactions before the tag may need to be replaced, however, ten years is the guarantee. However, there is a tag with a 40-year guarantee provided by the vendor (Jharotia, 2010).

The development of technology like today hopes to be able to solve problems that are often encountered in human activities, one of which is security problems. One of the security problems that we often encounter is the problem of unlocking the door of the house or locking the door of the room. With conventional locks that are often used, it is felt that they are not effective enough because of the many obstacles that are often encountered, for example, the lock used is jammed or makes it easier for thieves to break into the door. Utilizing technology that is now increasingly sophisticated is expected to reduce problems like the one above with new innovations so that the keys used are more comfortable and safe when used.

Related to some understanding of the advantages of using existing RFID systems, this research will design a model and simulation of a door security system using Arduino UNO microcontroller-based RFID and Mifare RC-522 (RFID reader). In this study, RFID tags as house keys will be identified using an RFID reader that has been designed together with the Arduino UNO microcontroller.

LITERATURE REVIEW

The Concept of Radio Frequency Identification (RFID)

Radio-Frequency Identification (RFID) is the use of radio waves to read and capture information stored on a tag attached to an object (Nisar et al., 2019). A tag can be read up to how far it is and does not need to be in close proximity to the reader to be tracked. According to Bagirathi et al., (2016) said RFID is a technology that uses radio frequency to identify an item or object (Bagirathi et al., 2016).



Figure 1. RFID Tag

According to Maryono (2005), RFID is an identification method using a facility called RFID or a transponder (tag) to store and retrieve data remotely. RFID is a method that can be used to store or receive data remotely

using a device called an RFID tag or transponder (Ilie-Zudor et al., 2011). So it can be concluded that RFID is a technology that uses radio waves to automatically identify an object from a distance or a short distance.



Figure 2. RFID Reader

Arduino Microcontroller Concept

The Arduino microcontroller is an open-source electronic circuit, in which the main component is a microcontroller chip of the Atmel AVR ATmega328 series from the Atmel company (Nugraha et al., 2022). The microcontroller itself is a chip that can be programmed using a computer. According to Feri Djuandi, Arduino is a microcontroller board based on ATmega328, which has 14 input/output pins of which 6 pins can be used as PWM outputs, 6 analog inputs, a 16 MHz

crystal oscillator, a USB port, a power jack, ICSP header, and reset button.

The Arduino Uno microcontroller is a microcontroller development board based on the ATmega328P chip. Arduino Uno has 14 digital input/output pins or commonly written I/O, of which 14 pins can be used as PWM outputs, including pins 0 to 13, 6 analog input pins, using a 16 MHz crystal, including pins A0 to A5, USB connection, a power jack, an ICSP header, and a reset button (D'Ausilio, 2012). This is all that is needed to support a microcontroller circuit.

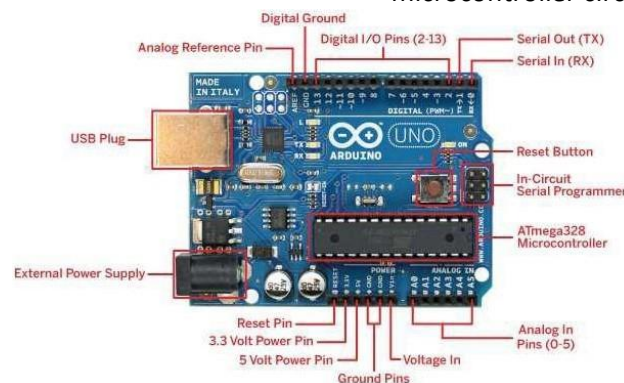

Figure 3. Arduino Uno Board

How Radio Frequency Identification (RFID) Works

RFID is an electronic device that has a wireless identification system that allows contactless data retrieval. The working principle of RFID is that the system performs identification using radio waves. For this reason, the process of using RFID requires two devices, namely TAG and Reader (Finkenzeller & Müller, 2010). When scanning data, Reader will read the signal given by the RFID Tag.

RFID Tag is a tool attached to an object to be identified by an RFID Reader. RFID Tags can be passive or active devices. Passive tag means without a battery and active tag means using the battery (Kelm et al., 2013). Passive tags are more widely used because they are cheap and have a smaller size. An RFID Tag can be a read-only device which means it can only be read or a read-write device which means it can be read and rewritten for updates.

RFID Reader is an RFID Tag reader tool. There are two kinds of RFID readers, namely passive readers (PRAT) and active readers (ARPT) (Seol et al., 2017). Passive readers have a passive reader system that only receives radio signals from active (battery/power source) RFID tags. The range of passive RFID receivers can be up to 600 meters. This enables the application of RFID for asset protection and monitoring systems. An active reader has an active reader system that transmits an interrogator signal to the Tag and receives an authentication reply from the Tag. This interrogator signal also induces the Tag and finally becomes a DC signal which becomes the passive Tag power source (Curty et al., 2006).

How Liquid Crystal Display (LCD) Works

In general applications, RW is assigned a logic "0" low. The data bus consists of 4-bit or 8-bit. If the data path is 4-bit then DB4 to DB7 is used. As seen in the description table, the LCD interface is a parallel bus, which makes it very easy and fast to read and write data from

or to the LCD (Ali & Radeep, 2014). The ASCII code displayed as 8 bits is sent to the LCD 4-bits or 8-bits at a time. If 4-bit mode is used, 2 nibbles of data are sent to make it fully 8-bit (4-bit MSB is sent first, then 4-bit LSB with an EN clock pulse for each nibble). The EN control line is used to inform the LCD that the microcontroller is sending data to the LCD (Prasojo et al., 2021). To send data to the LCD, the program must set EN to high "1" and then set the other two control lines (RS and R/W) or also send data to the data bus lines.

When the other line is ready, EN must be set to "0" and wait a while (depending on the LCD datasheet) and set EN back to high "1". When the RS line is in a low "0" condition, the data sent to the LCD is considered a special command or instruction (such as cleaning the screen, cursor position, etc.). When RS is high or "1", the data sent is ASCII data which will be displayed on the screen. For example, to display the letter "A" on the screen, RS must be set to "1". The R/W control line must be in low (0) condition when the information on the data bus is to be written to the LCD. If the R/W is in a high "1" condition, the program will query (read) the data from the LCD. There is only one reading instruction, namely, Get LCD status (reading LCD status), the others are writing instructions. So almost every application that uses the LCD, R/W is always set to "0". Data paths can consist of 4 or 8 paths (depending on the mode selected by the user), DB0, DB1, DB2, DB3, DB4, DB5, DB6, and DB7. Sending data in parallel in either 4-bit or 8-bit are the 2 primary modes of operation. To create an LCD interface application, the specified operating mode is of utmost importance (Ali & Radeep, 2014).

8-bit mode is best used when speed is a priority in an application and at least 11 I/O pins are available (3 for control, 8 for data). While the 4-bit mode only requires a minimum of 7-bit (3 pins for control, 4 pins for data). The RS bit is used to select whether data or instructions are to be transferred between the microcontroller and the LCD. If

this bit is set ($RS = 1$), then the byte at the current LCD cursor position can be read or written. If this bit is reset ($RS = 0$), it is the instruction sent to the LCD or the execution status of the last instruction read (Ali & Radeep, 2014).

How Solenoid Doorlock Works

Electronic door locks generally use solenoids. Solenoid door locks are electronic devices whose working principle is electromagnetic (Riyanto, 2018). Solenoid door locks generally use a working voltage of 12 volts. Under normal conditions, this device is in a closed condition (locking the door), when it is given a voltage of 12 volts the lock will open. To control the Solenoid door lock from Arduino, an interface or driver circuit is needed. One of them can use a 5-volt relay (Falohun et al., 2021). By using this relay, the Solenoid door lock can be controlled by the Arduino microcontroller.

How the Relay Module Works

The relay module is a device that operates based on electromagnetic principles to move the contactor to move the ON to OFF position or vice versa by utilizing electricity. Basically, the function of the relay module is an electric switch. Where it will work automatically based on the given logic command (Hasibuan et al., 2021). Mostly, 5-volt DC relays are used to make projects where one of the components requires high voltage or one that is AC (Alternating Current) in nature. While the use of relays more specifically is to carry out the logic functions of the Arduino microcontroller, a means to control high voltages using only low voltages, minimize the occurrence of voltage drops, allow the use of time delay functions or time delay functions, protect other components from an excess voltage that causes short circuits, and simplifies the circuit to make it more concise. The relay can work because of the electromagnetic force that is created from an iron core which is wrapped around the coil wire and is electrified (Gurevich, 2018). When

the coil is electrified, the iron core will automatically become a magnet and attract the support so that the condition that was originally closed becomes open.

RESEARCH METHODS

The research was carried out using the waterfall method, with the stages of identifying problems, at this stage, collecting all the necessary materials and data, grouping problems, and solving problems. System analysis, analyzing information and problems obtained from the initial stage and also analyzing overall and detailed needs. System Design, at this stage, program design, circuit models, and flowcharts are started. Writing program code, at this stage, coding is carried out in a predetermined programming language based on the overall design. Assembling the tools that have been determined based on the design that has been made. System testing, at this stage, the tool will be tested for conformity with what was designed and carried out tests to detect existing problems and make improvements (Kramer, 2018).

3528

RESULTS AND DISCUSSION

Results

Problem Analysis Results

The door opening system that is locked using a slot key is generally still done manually, the key is a type of fastening device to prevent the door leaf or other cover from opening from its original position. Locks that are installed on doors of houses, cupboards, cars, motorcycles, chests, or others, generally consist of two parts, namely the main and the key, the main function of the key is to unite or link the two parts, for example, the door leaf and the frame so that it cannot be opened without a tool. special. This special opening and fastening tool are called a key, but there are also other types of locks such as padlocks (hanging locks) which can be fastened without a key and the key is only needed when opening it. Another type of lock that works in common with a house door is a car or

motorcycle steering wheel lock. This type is different from the ignition of a car or motorbike, which functions to connect the electrical circuit to the engine ignition system so that the engine can be started.

All locks have a Grendel that is able to prevent the door from opening, the Grendel remains locked when the partner's key is not used to open it. The latch in the main lock can be opened when the lever can be rotated. The Grendel lever is equipped with a series of metal pegs, each of which is composed of two halves with a spring. These pairs of metal pegs have unequal lengths, so that the location of the connection between the lower and upper pegs, each of which is equipped with a spring, is not in a straight line. This is what causes the lever not to rotate freely. The key lock has a depression with a depth and a protrusion that each corresponds to the main pegs of the lock so that when the key is inserted, the connection of the pins lies in a straight line. The straight position that frees this lever causes the Grendel to be opened. Depending on the level of security required, in one lock there can be three to seven pairs of pegs.

There are several types of locks, one of which is the lock on the door of the house. The opening and closing system is generally

still done manually by turning the key or sliding a slot. Basically, house door locks are divided into two types, namely conventional locks which are commonly used manually, and digital locks which are more modern and considered capable and reliable for guarding the door of the house. Conventional door locks consist of lever locks, slot locks, and cylinder locks.

Based on the results of the analysis and research conducted by the author, the workings of each lock are still done manually by rotating and moving the door lock. Therefore, the author will change the way the door lock works from manual to automatic, in a way if the door is locked then it is opened by attaching an automatic card to the tool that has been provided later, and the locked slot will be opened with.

3529

System Design Results

System design is a stage of the process to find out what things are needed in building the system to be formed. The design of this system will include designing outputs, inputs, file structures, programs, procedures, hardware, and software that can support system design.

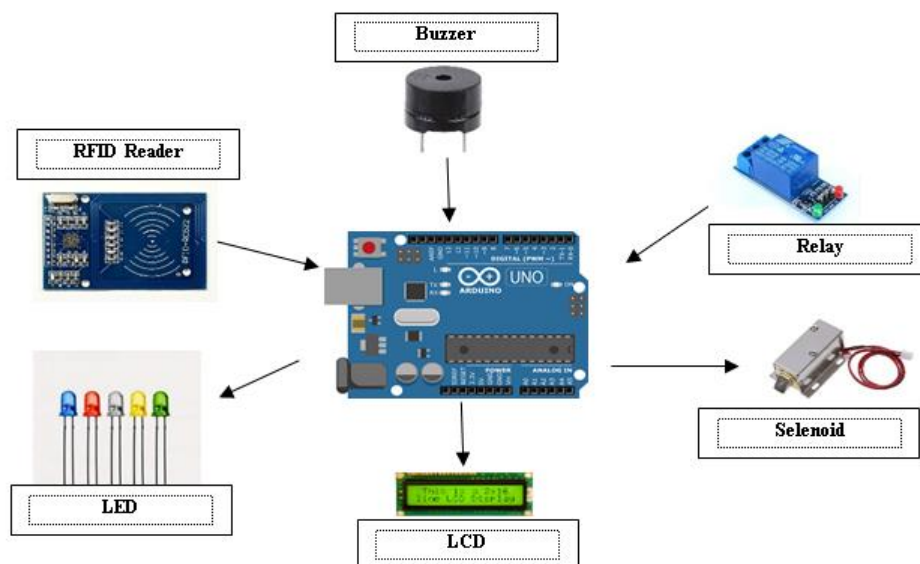

Figure 4. Flow System

Arduino acts as a core device that is equipped with electronic components so that programs can be directly filled in according to their needs and functions. This door opener system can be used to develop servo motor movement applications, as well as RFID work systems. This system is made for simulating an automatic door opener through an RFID device so that the output produces a value through several sensors, this value will be processed in the Arduino device. The parameter used is the RFID card attached to the RFID Reader from a sensor that has been pre-processed on Arduino. Then, these results will drive the servo motor to open the lock slot. If the RFID card has been registered, the servo motor will move to shift the locked key

slot so that the key slot is open and if the RFID card has not been registered, the servo motor will not move to shift the key slot.

The system consists of input, process, and output devices. Input is the result of reading from the RFID card attached to the RFID reader. The process of managing data from an RFID card is processed into a program on Arduino which will then be processed by a servo motor. Output is the result of data that has been processed by Arduino which will drive the servo motor. If the RFID card is attached and the tag ID has been registered, the servo motor will shift the slot lock, and if the RFID card to which the tag ID is attached has not been registered, the servo motor will not move.

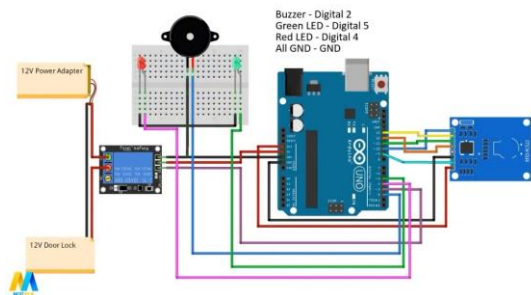

Figure 5. Smart Doorlock Hardware Design

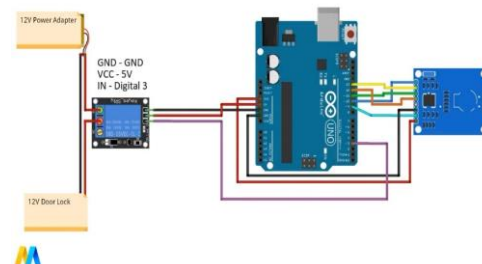

Figure 6. Design of Solenoid Doorlock and Relay Module

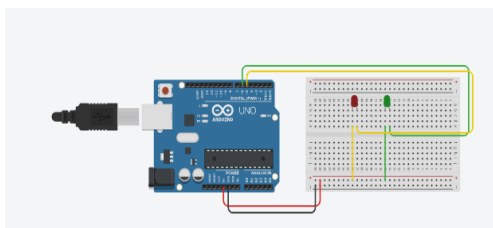

Figure 7. Desain LED

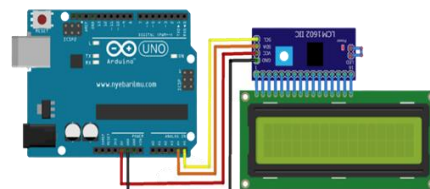

Figure 8. Desain LCD 6x12

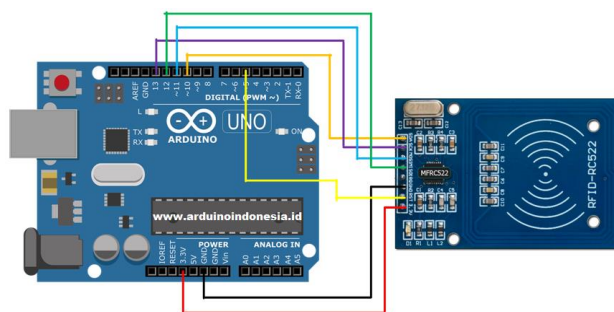

Figure 9. Desain RFID

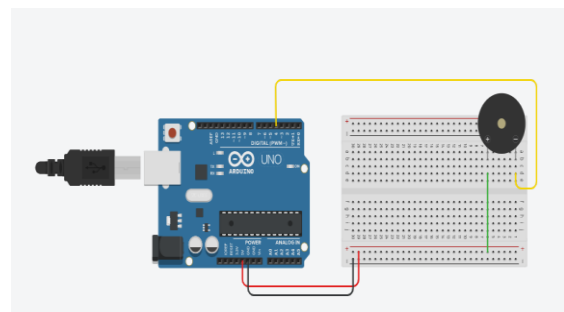

Figure 10. Desain Buzzer

Arduino is an electronic board instrument composed of chip support devices that can be embedded in programs. The components of this Arduino are microcontrollers that are planted in each series, in each Arduino series using a different microcontroller according to their needs. Arduino Uno has an ATmega328 microcontroller and the programming language used is C language. In essence, data is input via the input pin, then the input data is received by the microcontroller for processing, then the data will be sent back to the output pin.

The first stage of how Arduino works is the input component that is connected to the Arduino device, then Arduino will read or measure the data that becomes the trigger. In this research, an RFID card is attached to the RFID reader. Data is sent to the Arduino input pin, the input pin is the intermediary that connects the Arduino and the input component. So, the data obtained from reading the component input will be sent to

the Arduino input pin. Data enters the microcontroller, and data on the Arduino input pin will be sent to the microcontroller to continue the data processing stage. Data entered into the microcontroller will be processed based on the input program. Also in this stage, the command will be executed and run by the output device. Programs processed by the Arduino microcontroller use the C language using the Arduino IDE software. Then the data is sent to the Arduino output pin, after the data is processed, the next step is the data sent to the Arduino output pin. Like the input pins, Arduino output pins also act as intermediaries that connect Arduino and output components. Finally, the data is sent to the output component, the data that is on the Arduino output pin will then be sent to the output component. So, all program commands given by the microcontroller will be directly executed by the output components.

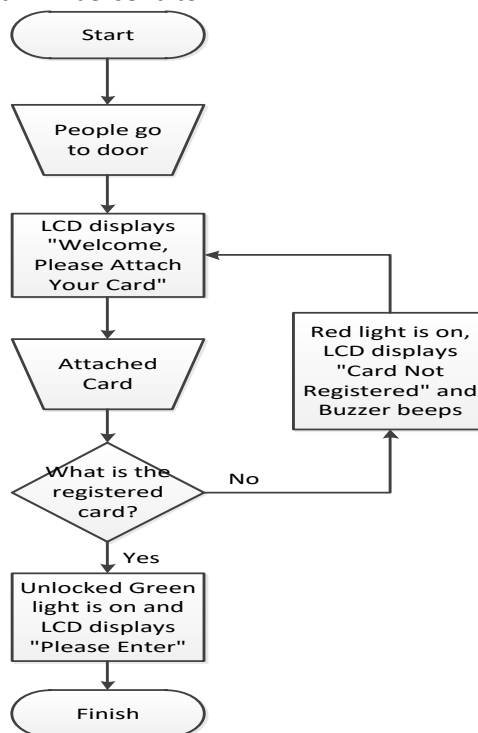

Figure 11. Flowchart of Smart Doorlock System

Discussion

System Implementation

System implementation is the process of implementing the system that has been designed, this stage is the stage of putting the system ready for use and also as an effort to realize the system that has been designed.

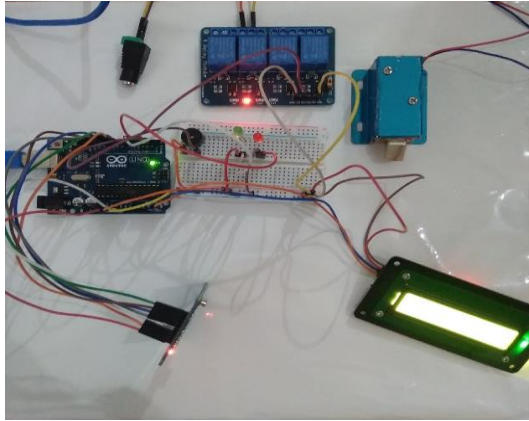

Figure 12. Simulation of Smart Doorlock System

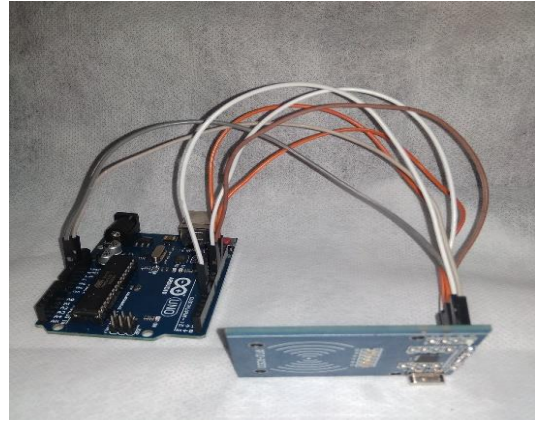

Figure 13. RFID Installation

3532

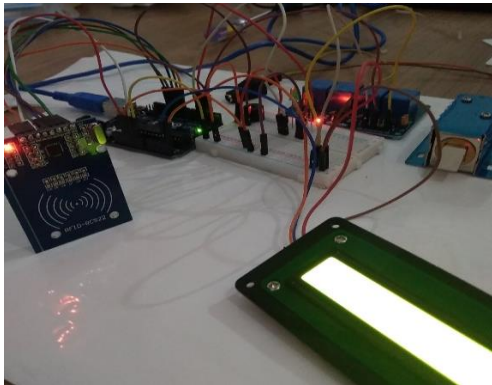

Figure 14. Door Lock Solenoid Installation

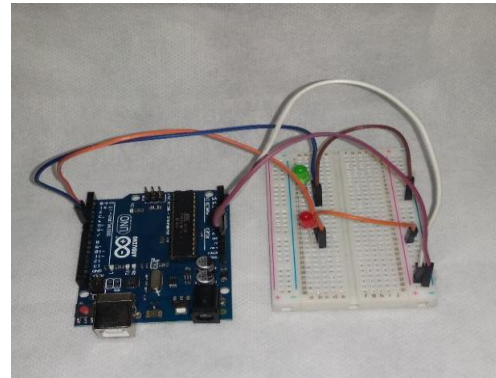

Figure 15. Installation of LEDs

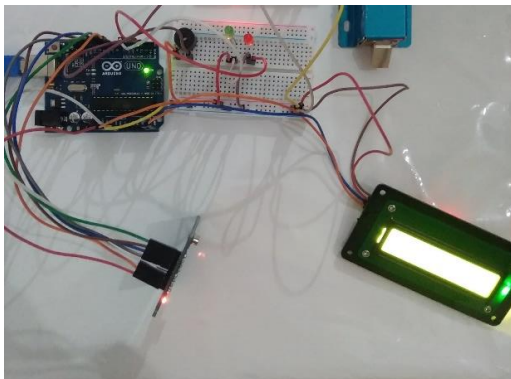

Figure 16. Installation of 16x12 LCD

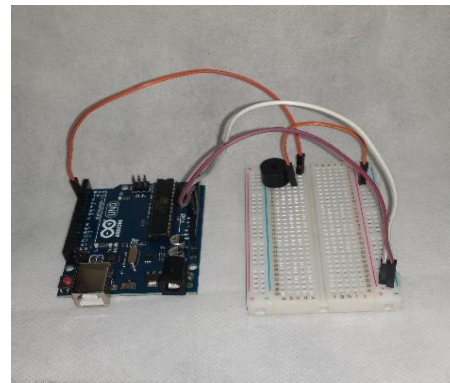

Figure 17. Buzzer Installation

System Testing

After the system design has been completed, the next thing is to look at the test

results, there are several aspects that will be seen in the test results, including RFID Reader testing, Solenoid testing, LCD testing and

www.neuroquantology.com



finally testing the distance between the RFID sensor and the ID Card. Initial testing of the LED indicator light voltage is carried out to find out how much voltage is there when the light is off (OFF) and when the light is on (ON), by measuring the voltage on each LED indicator light. Based on the results of LED testing when the OFF condition is 0 Volt and when the LED is ON the voltage is 5 Volts.

Next, test the relay and buzzer voltages to find out how much voltage is when the condition is OFF and when the condition is ON, by measuring the voltage on each of the

existing components. Based on the results of the relay test when the OFF condition is 0 Volt and when the Relay is ON the voltage is 5 Volts, the same results are obtained in the buzzer test.

LCD testing is carried out to find out or display the access status and also attach the ID Card which is then displayed on the LCD screen. Based on the tests carried out, it shows that the LCD is functioning properly, and can display the status "Welcome, Please Attach Your Card", "Card Not Registered", and "Please Enter".

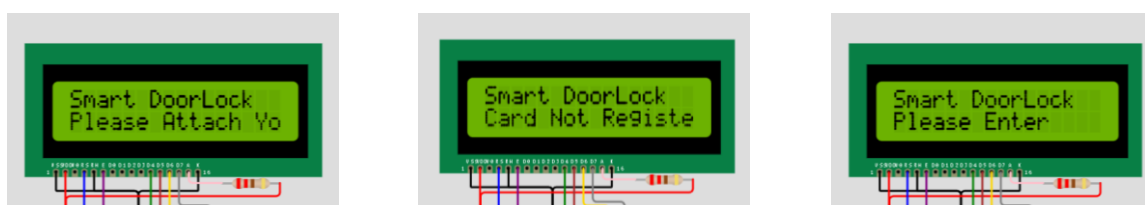

Figure 18. Testing of LCD Display

Testing the reading distance of the RFID reader sensor with the Id Card is carried out using a ruler. Measuring the distance between the ID Card and the RFID reader aims to find out how far the RFID ID Card reader can read. Testing the ID Card to open the selenoid doorlock is carried out by attaching the ID Card to the RFID reader which aims to determine the distance the ID Card can unlock the door with the result that a minimum reading distance of 0 cm is obtained and a maximum reading distance of 4 cm.

CONCLUSION AND RECOMMENDATIONS

Conclusion

Based on the analysis, design, and testing it can be concluded that when the RFID tag (ID Card) is brought close to the RFID reader, the door opens. Then, if the RFID tag used does not match, the buzzer will sound. The reading distance of each RFID tag by the RFID reader is a maximum of 4 cm. In addition, the barrier object or media between the RFID tag and the RFID reader also determines the success of data reading. The key used is a solenoid door lock with the help of a relay. Arduino Uno can be used as a data processing microcontroller for automatic door unlock systems. The key

used is a type of key slot, namely a Selenoid Doorlock with the help of a relay. RFID readers can read RFID tags as sensors to unlock automatic doors. Buzzer, LCD, and LED function as indicators to detect doors using RFID, if RFID is registered, the buzzer sounds, the LCD displays "Please Enter" and the green LED lights up. if the RFID is not registered, the buzzer sounds, the LCD displays "Card Not Registered" and the red LED lights up.

REFERENCES

- Ali, M. Z., & Radeep, Y. (2014). Design of Electronic Sensor for Blood Pressure Monitoring System Based on Zigbee Module System. *Int. Journal of Scientific Engineering and Technology Research*, 03(50), 10200–10208.
- Bagirathi, S., Sankar, S., & Sandhya. (2016). Tag detection in RFID system based on RSSI technique for LF and HF passive tags. *2016 International Conference on Communication and Signal Processing (ICCSP)*, 452–456. <https://doi.org/10.1109/ICCSP.2016.7754177>
- Baloch, A., Baloch, S., & Kumar, N. (2018). Performance Comparison of RFID and Barcode. *Engineering Science and Technology International Research Journal*, 2(3), 8–15.

www.estirj.com

Bibi, F., Guillaume, C., Gontard, N., & Sorli, B. (2017). A review: RFID technology having sensing aptitudes for food industry and their contribution to tracking and monitoring of food products. *Trends in Food Science & Technology*, 62, 91–103. <https://doi.org/https://doi.org/10.1016/j.tifs.2017.01.013>

Chen, Q., Adey, B. T., Haas, C., & Hall, D. M. (2020). Using look-ahead plans to improve material flow processes on construction projects when using BIM and RFID technologies. *Construction Innovation*, 20(3), 471–508. <https://doi.org/10.1108/CI-11-2019-0133>

Curty, J. P., Declercq, M., Dehollain, C., & Joehl, N. (2006). *Design and Optimization of Passive UHF RFID Systems*. Springer US. <https://books.google.co.id/books?id=uFjpH3C17z8C>

D'Ausilio, A. (2012). Arduino: A low-cost multipurpose lab equipment. *Behavior Research Methods*, 44(2), 305–313. <https://doi.org/10.3758/s13428-011-0163-z>

Falohun, A. S., Makinde, B. O., Adegbola, O., Falohun, A., Makinde, B. O., Adegbola, O. A., Akin-Olayemi, T. H., Adeyeye, A. E., Adeosun, A. E., & Akande, B. D. (2021). Design and Construction of a Smart Door Lock With an Embedded Spy-Camera. *Journal of Multidisciplinary Engineering Science and Technology (JMEST)*, 8(7), 2458–9403. <https://www.researchgate.net/publication/354872757>

Finkenzeller, K., & Müller, D. (2010). *RFID Handbook: Fundamentals and Applications in Contactless Smart Cards, Radio Frequency Identification and Near-Field Communication*. Wiley.

<https://books.google.co.id/books?id=jAszZEQYa9wC>

Gurevich, V. (2018). *Electric relays: principles and applications*. CRC Press.

Hasibuan, A., Qodri, A., & Isa, M. (2021). Temperature Monitoring System using Arduino Uno and Smartphone Application. *Bulletin of Computer Science and Electrical*

Engineering, 2(2), 46–55. <https://doi.org/10.25008/bcsee.v2i2.1139>

Ilie-Zudor, E., Kemény, Z., van Blommestein, F., Monostori, L., & van der Meulen, A. (2011). A survey of applications and requirements of unique identification systems and RFID techniques. *Computers in Industry*, 62(3), 227–252.

<https://doi.org/https://doi.org/10.1016/j.comind.2010.10.004>

Jharotia, A. K. (2010). RFID Technology: Security System in Modern. *International Journal of Librarianship and Administration*, 1(1), 31–43.

Kelm, A., Laußat, L., Meins-Becker, A., Platz, D., Khazaee, M. J., Costin, A. M., Helmus, M., & Teizer, J. (2013). Mobile passive Radio Frequency Identification (RFID) portal for automated and rapid control of Personal Protective Equipment (PPE) on construction sites. *Automation in Construction*, 36, 38–52. <https://doi.org/https://doi.org/10.1016/j.autcon.2013.08.009>

Kramer, M. (2018). Best Practices in Systems Development Lifecycle: an Analyses Based on the Waterfall Model. *Review of Business & Finance Studies*, 9(1), 77–84. https://papers.ssrn.com/sol3/papers.cfm?abstract_id=3131958

Nisar, K., Ibrahim, A. A. A., Park, Y. J., Hzhou, Y. K., Memon, S. K., Naz, N., & Welch, I. (2019). Indoor Roaming Activity Detection and Analysis of Elderly People using RFID Technology. *2019 1st International Conference on Artificial Intelligence and Data Sciences (AiDAS)*, 174–179. <https://doi.org/10.1109/AiDAS47888.2019.8970780>

Nugraha, A. R., Haryanto, D., Yulianeu, A., & Sukmaindrayana, A. (2022). *Implementation of Fuzzy Logic for Fire Detection Systems in Buildings Based on Internet of Things*. 20(16), 1332–1342.

<https://doi.org/10.14704/NQ.2022.20.16.NQ880132>

Prasojo, I., Maseleno, A., Tanane, O., & Shahu, N. (2021). The design of earthquake detector using pendulum swing based on ATMega328.

3534



- Journal of Robotics and Control (JRC)*, 2(3), 209–211. <https://doi.org/10.18196/jrc.2380>
- Rathke, C. (2021). The Women Who Don't Get Counted. *Voices in Bioethics*, 7. <https://doi.org/10.52214/vib.v7i.8717>
- Riyanto, E. (2018). Home Security Based on Raspberry and Android (Smart Home). *Jaict*, 3(2), 1–4.
- Seol, S., Lee, E.-K., & Kim, W. (2017). Indoor mobile object tracking using RFID. *Future Generation Computer Systems*, 76, 443–451. <https://doi.org/https://doi.org/10.1016/j.future.2016.08.005>
- Shahid, S. M. (2005). Use of RFID technology in libraries: A new approach to circulation, tracking, inventorying, and security of library materials. *Library Philosophy and Practice*, 8(1).
- Statistik, B. P. (2021). *Statistik Kriminal 2021* (D. S. K. Sosial (ed.)). Badan Pusat Statistik.
- Sudarto, F., Gustasari, G., & Arwan, A. (2017). Perancangan Sistem Smartcard Sebagai Pengaman Pintu Menggunakan Rfid Berbasis Arduino. *CCIT Journal*, 10(2), 239–254. <https://doi.org/10.33050/ccit.v10i2.544>

